



Summit™ single-use arthroscope

Instructions for Use

1. Image Processing Unit (IPU)

Catalog - REF: PS-IPU001

2. Summit™ single-use arthroscope

Catalog - REF: PS-ART001



Read all instructions carefully before use.

Pristine Surgical
Brady Sullivan Tower, 6th Floor
1750 Elm Street
Manchester NH 03104
www.pristinesurgical.com | 1-888-304-0004

Contents

1	Warnings and Notes	3
2	Indications for Use	3
3	Description	3
4	Unpacking, Inspection, and Storage	6
5	Instructions for Use	8
5.1	Set Up	9
5.1.1	IPU Set Up.....	9
5.1.2	Arthroscope Set Up	10
5.1.3	Disengaging Obturator from Cannula	12
5.1.4	Mating arthroscope to Cannula	13
5.2	Use	14
5.2.1	Control Button Functions / Media Processing	14
5.2.2	Summit Settings App	15
5.2.3	Summit Voice Assistant	19
5.2.4	Camera View	21
5.2.5	Shut Down	22
6	Care, Maintenance, and Disposal	22
7	Icons and Indicators on Video Display Monitor	23
8	Troubleshooting	25
8.1	Messages on Video Display Monitor	26
9	Technical Description	28
9.1	Technical Specifications	28
9.2	Electromagnetic Compatibility	30
10	Symbols Used on the System	35
11	Abbreviation Glossary	38
12	Customer Service	38

1 Warnings and Notes

IMPORTANT SAFETY INFORMATION—PLEASE READ BEFORE USE

The tags “WARNING” and “Note” are used throughout this Instructions for Use Manual to highlight important information and should be carefully reviewed for the safe and effective operation of the Summit™ single-use arthroscope.

All **Warnings** are accompanied by the following symbol:



A **WARNING** indicates a mandatory or prohibitive action that, if ignored, could lead to patient or user harm.

A **Note** provides additional information about the system.

2 Indications for use

The Pristine Summit™ single-use arthroscope is an endoscopic device introduced into a patient to provide an internal view or image of the interior of a joint for examination, diagnosis, and/or therapy. The Pristine Summit™ single-use arthroscope is indicated for use in arthroscopic procedures performed in the hip, knee, and shoulder.

Contraindications:

The Pristine Summit™ single-use arthroscope is contraindicated for use when such use would jeopardize the patient’s health and safety.

3 Description

The Pristine Summit™ single-use arthroscope consists of an arthroscope with accessories and an Image Processing Unit (IPU) with accessories.

The Pristine Summit™ single-use arthroscope allows the user to illuminate and visualize an interior joint in the body.

The arthroscope is a single-use, disposable rigid endoscope that is provided sterile. It has an integrated LED light source digital camera, communication cable, and irrigation tubing. Accessories include a disposable obturator and a cannula. The arthroscope has controls for still image capture, video capture, and camera rotation. The arthroscope receives power from the IPU via its communication cable.

The IPU is a non-disposable, non-sterile image processing unit. The IPU has an arthroscope port, five (5) USB ports, a video monitor display port, a power switch, an ethernet port, a 3.5mm microphone jack port, a Wi-Fi antenna port, and a power cable connector. It receives high-definition video feed from the arthroscope and implements real-time distortion correction and exposure control. Accessories include a power cable, an optional DP to DVI adaptor and a Wi-Fi/Bluetooth antenna.

Refer to IEC 60601-1 for applicable requirements when installing, assembling, and modifying the system that are necessary to maintain compliance with the standard.

This manual does not include instructions for surgical procedures. The user of this instrument should be trained to perform the surgical procedures for which the device is indicated.

Note: A video display monitor, irrigation pump, and a USB Stick are not included with the Summit™ single-use arthroscope and are required to be used in this system.

Note: Arthroscope, Cannula, and Obturator are not made with natural rubber latex.

Arthroscope:

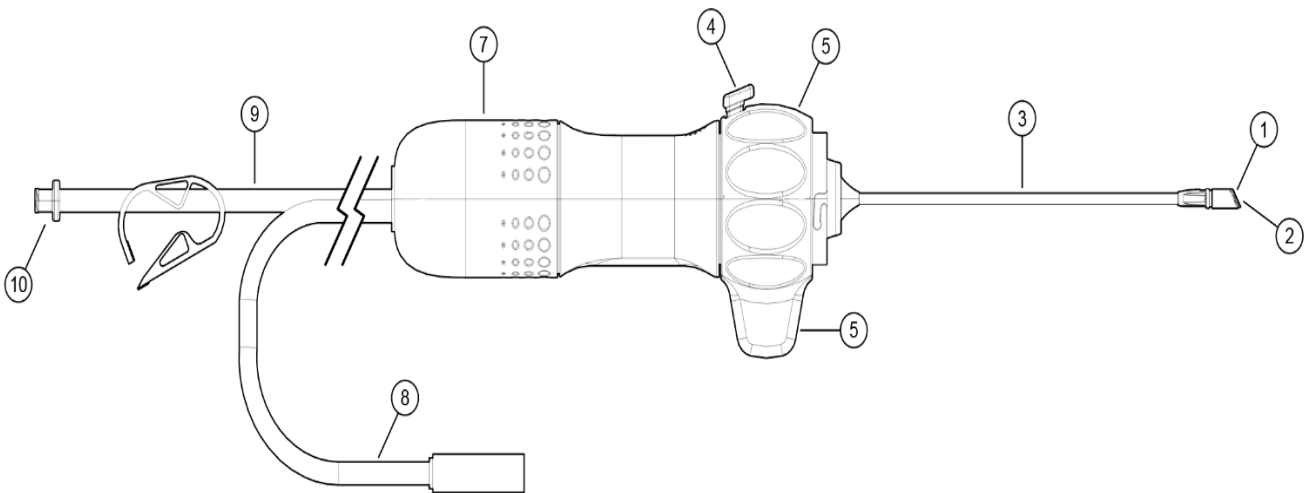

- | | | |
|----------------------|-------------------------|-------------------------|
| 1. Camera | 5. Fin | 9. Irrigation Tubing |
| 2. LED Light | 6. Control Handle | 10. Luer Lock Connector |
| 3. Arthroscope Shaft | 7. Back Handle | |
| 4. Control Button | 8. Communications Cable | |

Arthroscope Accessories:

Obturator:



1. Obturator Handle

Cannula:

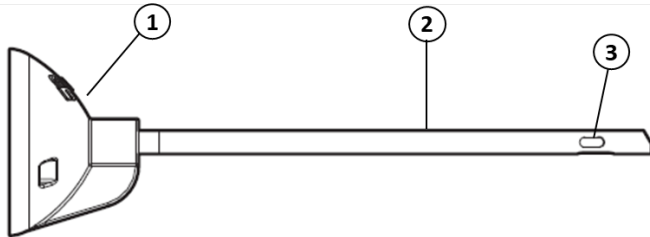

1. Cannula Hub

2. Cannula Shaft

3. Fluid Port

Image Processing Unit:

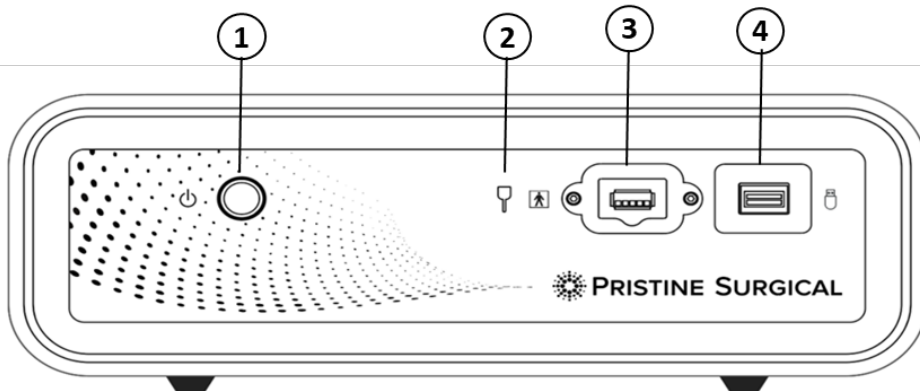

Front View

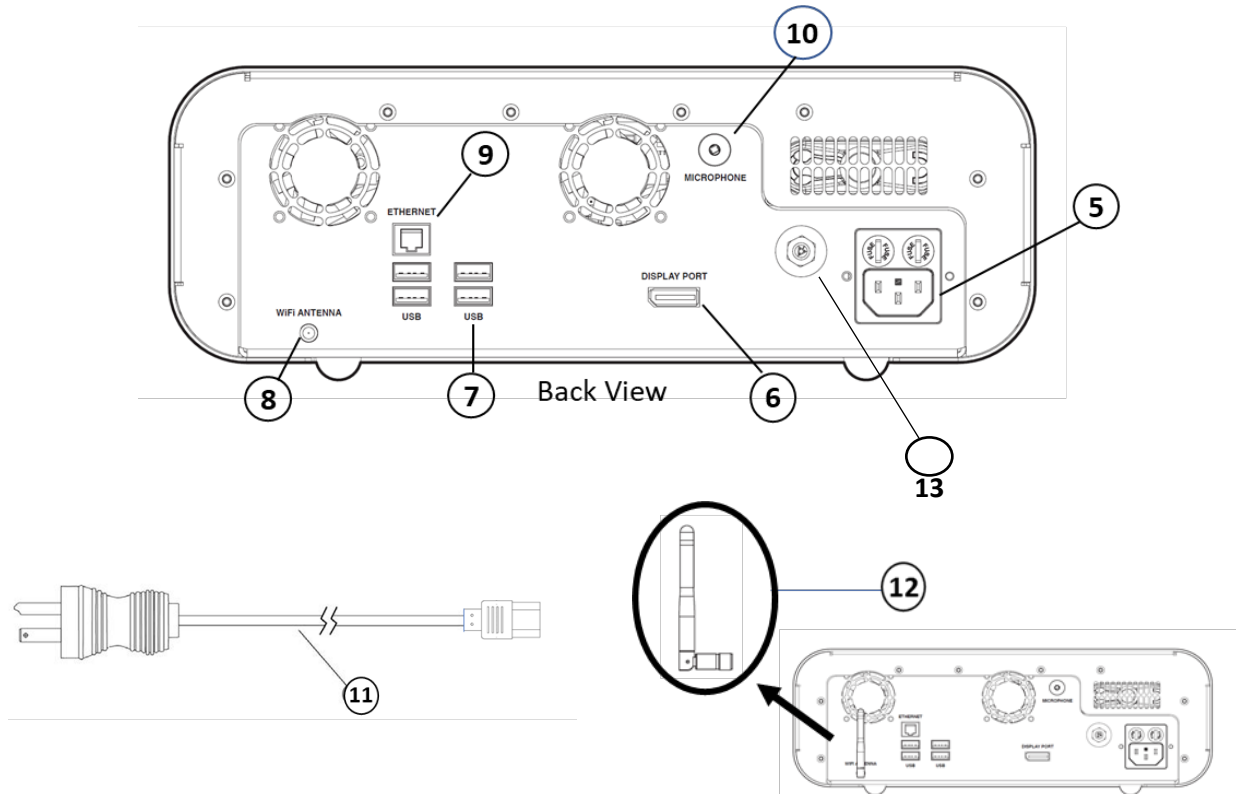

- | | |
|--------------------------------|----------------------------|
| 1. Power Button* | 8. Wi-Fi Antenna Port |
| 2. Scope Connected Indicator** | 9. Ethernet Port |
| 3. Scope Communication Port | 10. Mic. Port - 3.5mm |
| 4. Media Port - USB | 11. Power Cable |
| 5. Power Cable Connector | 12. Wi-Fi Antenna |
| 6. Video Display Port | 13. Equalization Conductor |
| 7. USB Ports | |
- * Power Button is illuminated White (Standby) and Blue (Operational)
 **Scope Connected Indicator will illuminate when cable is connected

4 Unpacking, Inspection and Set Up



Arthroscope Kit

Open the shipping carton being careful not to damage the contents. The arthroscope and accessories are provided sterile in a sealed tray. Remove and inspect the sealed tray for signs of damage or deterioration. Verify the expiration date has not lapsed. If there are signs of damage or deterioration do not use.

The Summit™ single-use arthroscope kit includes:

1. A single-use, disposable arthroscope. The 5mm, 30-degree arthroscope has an integrated LED light source, digital camera, communication cable, irrigation connection and tube clamp.
2. Cannula
3. Obturator

Note: Store the sterile sealed tray and outer box in a clean dry area. See technical specifications for recommended storage environment.

	WARNING: Do not use the arthroscope or its accessories if the sealed tray is punctured, damaged, or missing.
	WARNING: Do not use the arthroscope or its accessories after the expiration date.

Pristine Surgical IPU:

The IPU is packaged and shipped separately. Inspect the packaging for any signs of damage. Unpack the IPU, Power Cable, Wi-Fi Antenna, and DP to DVI adaptor. Connect the Power Cable to the Power Cable connector and plug the Power Cable into a mains power socket with a protective earth ground. Connect the Wi-Fi Antenna to the Wi-Fi Antenna Port and the video monitor cable (HDMI) to the Video Display Port. Both ports can be found on the back panel of the IPU.

Turn on the IPU using the Power Switch and verify the “connect scope” visual (Figure 1) appears on the video display monitor. Turn the IPU off using the Power Switch.

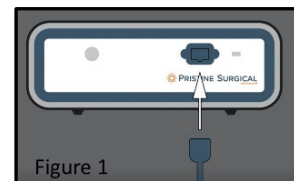

Figure 1

To access and modify settings on the IPU/Monitor, plug in keyboard/mouse via a USB port found on the back panel. Verify “Access Settings” appears (Figure 2) on the video display monitor. Access settings screen by pressing CTL+SHIFT + S simultaneously on the keyboard.

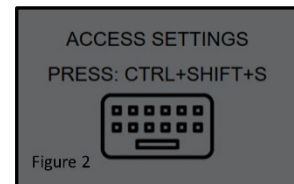



Figure 2

1. Connecting to a Wi-Fi network

- 1) Click on the Wi-Fi 
- 2) Click on appropriate available network.
- 3) Type in a password, if necessary, to complete the connection to the chosen network.



2. Connecting to Bluetooth enabled microphone.

- 1) Click on the Bluetooth 
- 2) Click on enable Audio Devices
- 3) Click on enable Bluetooth Devices
- 4) Click on Pairable Device and choose appropriate Bluetooth enabled microphone.

3. Setting Date and Time

- 1) Click on the Date/Time 
- 2) Set month, date, year by clicking on the appropriate tabs.
- 3) Set hour, minute based on a 24-hour clock (i.e., 4:00 pm is 16:00) by clicking on the appropriate tabs.
- 4) Set Time Zone by clicking on time zone and select from the drop-down menu selection of time zones.



4. Updating IPU Firmware

- 1)  This is the icon for updating firmware. For firmware updates, please reach out to Pristine Surgical. 

5. Summit Voice Assist





- 1) Click on Summit Voice Assist icon to pull up the SVA menu shown in figure 2 in section 5.2.3.

- 2) Say “SUMMIT TAKE PICTURE” and the system will take a picture.
- 3) Say “SUMMIT START VIDEO” and the system will start recording a video.
- 4) Say “SUMMIT STOP VIDEO” and the system will stop recording a video.

Note: Store the IPU in a clean, dry area. See technical specifications for recommended storage environment.

	WARNING: Connect the Image Processing Unit to a mains socket with protective earth ground to avoid the risk of electric shock.
	WARNING: Only use the Power Cable supplied with the Image Processing Unit and do not use the Power Cable if it has been damaged.

5 Instructions for Use

Before use, thoroughly inspect the entire arthroscope, especially the arthroscope shaft, cannula shaft, and the camera lens located at the distal tip of the arthroscope for any damage including scratches, dents, chips, or other irregularities.

	WARNING: Do not use the arthroscope or its accessories if they are damaged.
	WARNING: Do not use the arthroscope or its accessories if the sealed tray is punctured, damaged, or missing.
	WARNING: Do not use the arthroscope or its accessories after the expiration date.
	WARNING: Do not clean, disinfect, or re-sterilize the arthroscope or its accessories.
	WARNING: Only use the Communication Cable supplied with the arthroscope. Do not use USB extension cables, switches, or adapters as they can degrade image quality.

Note: Equipment that employs RF communications may affect the normal function of the IPU.

5.1 Set Up

5.1.1 IPU Set Up

Place the IPU outside of the sterile field.

Plug the Power Cable into the Power Cable Connector on the back of the IPU. Do not position the IPU so that it is difficult to disconnect the Power Cable from either the Power Cable Connector or the mains socket outlet to electrically isolate the IPU from the supply mains.

Plug the Power Cable into a mains power socket with protective earth ground. The Equalization Conductor may also be connected to the IPU, but it is not required for use. See IEC 60601-1 for additional requirements required for medical equipment systems.

Connect a monitor into the video monitor Display Port on the back of the IPU. The IPU supports the use of only one monitor at a time. To have audio recording for a recorded digital video, a microphone is needed.





The following equipment is approved for connection to the IPU: **1.** arthroscope via scope communication port, **2.** monitor via the video DisplayPort, **3.** USB stick via the media port, **4.** USB mouse and/or keyboard via the USB port(s), **5.** ethernet cable via the ethernet port, **6.** microphone via the mic port (3.5 mm), and **7.** a Wi-Fi antenna via the Wi-Fi antenna port. No other devices are intended for use with the IPU.

The IPU accepts two types of microphones.

1. Microphone with a 3.5mm jack - The 3.5mm jack is plugged into the microphone port found on the back panel of the IPU

2. Bluetooth Enabled Microphone - The IPU is Bluetooth compatible for a wireless microphone connection.

Note: In order to capture and record digital content, a USB stick needs to be inserted into the Media Port on the front of the IPU.

	WARNING: Connect the Image Processing Unit to a mains socket with protective earth ground to avoid the risk of electric shock.
	WARNING: Only use the Power Cable supplied with the Image Processing Unit.
	WARNING: Do not remove panels or guards from the IPU.
	WARNING: Do not use any additional switches or adaptors in between the IPU and monitor other than a single DisplayPort cable
	WARNING: Do not connect the Image Processing Unit to a Multiple Socket Outlet.



WARNING: Only connect the approved equipment that has been deemed compatible with the Image Processing Unit.

5.1.2 Arthroscope Set Up

Inner Sterile Tray Configuration – top view (sitting in the external tray)

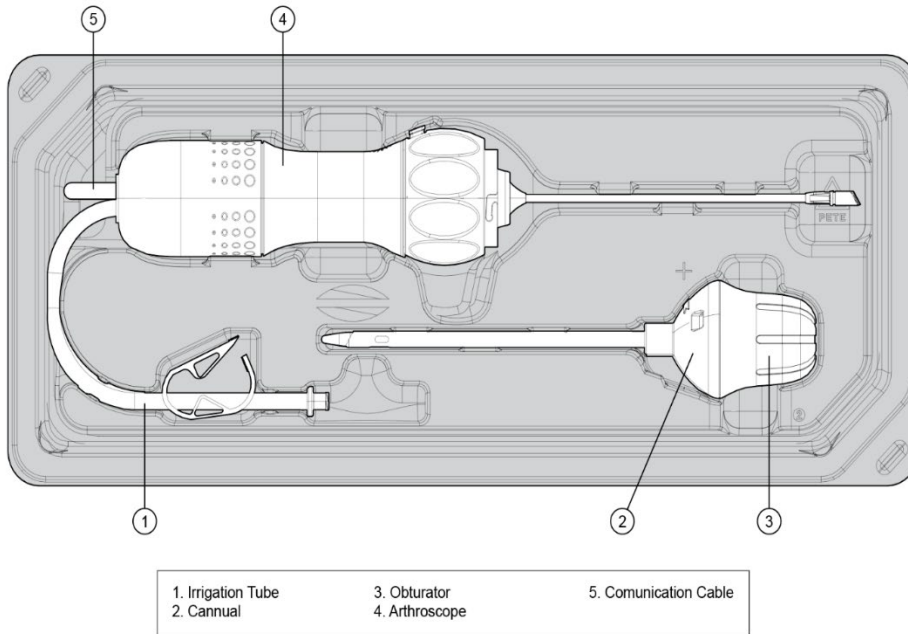

Inner Sterile Tray Configuration – bottom view

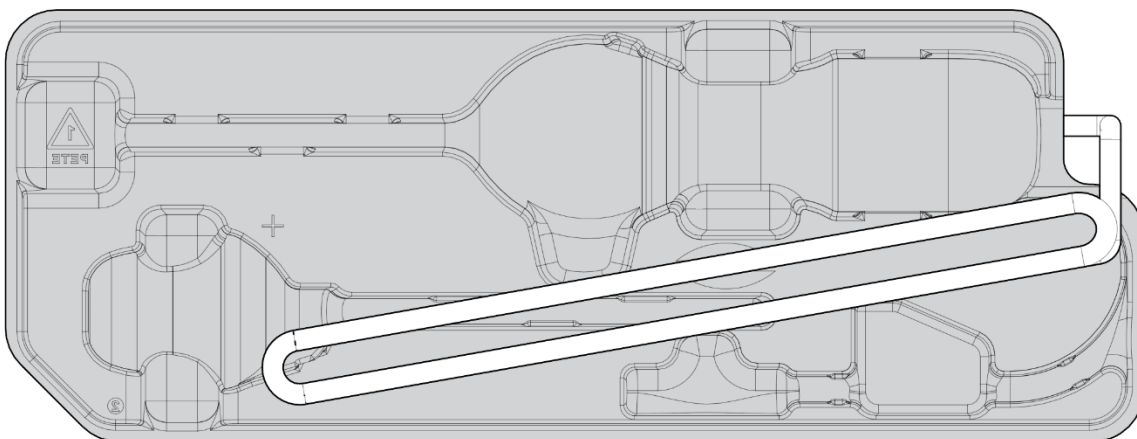

WARNING: Use appropriate aseptic practices when removing the arthroscope and its accessories from their sterile packaging.

Remove the protective sterile barrier cover from the external tray. Place the inner sterile tray onto the sterile field in an aseptic manner and remove the arthroscope and accessories from the inner tray.

Note: Have a sterile “stand-by” arthroscope available in the event of loss of function of the arthroscope.

Turn on the IPU using the Power Switch



Confirm “connect scope cable” image appears on the video display monitor screen.

Connect the Communication Cable to the Scope Communication Port on the front of the IPU. Scope Connected Indicator on the front of the IPU will illuminate when the cable is connected correctly to the IPU.

Connect the Irrigation Tubing to an irrigation line to allow fluid to run from an irrigation bag or pump through the arthroscope shaft into the patient. Activate the pump. Verify that fluid flows through the arthroscope Shaft.



WARNING: Prime the fluid path of the arthroscope with the irrigation fluid before using the irrigation function to avoid the risk of an air embolism.

Verify the Control Button on the arthroscope handle functions properly. Press and hold the Control Button for at least 3 seconds to turn the LED on. Press and hold the Control Button for at least 3 seconds to turn the LED off.

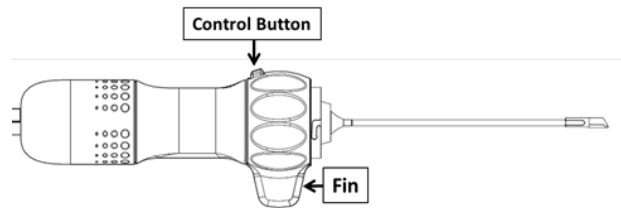

Note: Arthroscopes manufactured from December 2023 no longer have this function. LED is on and cannot be turned off.

Use the fin to rotate the Control Handle clockwise and counterclockwise to confirm the Rotation Marker on the monitor rotates with the Control Handle.



WARNING: Before use, check to confirm the image is live, and has the correct orientation.



WARNING: Do not look directly at the arthroscope light source or point the arthroscope light source at another individual.

5.1.3 Disengaging Obturator from Cannula

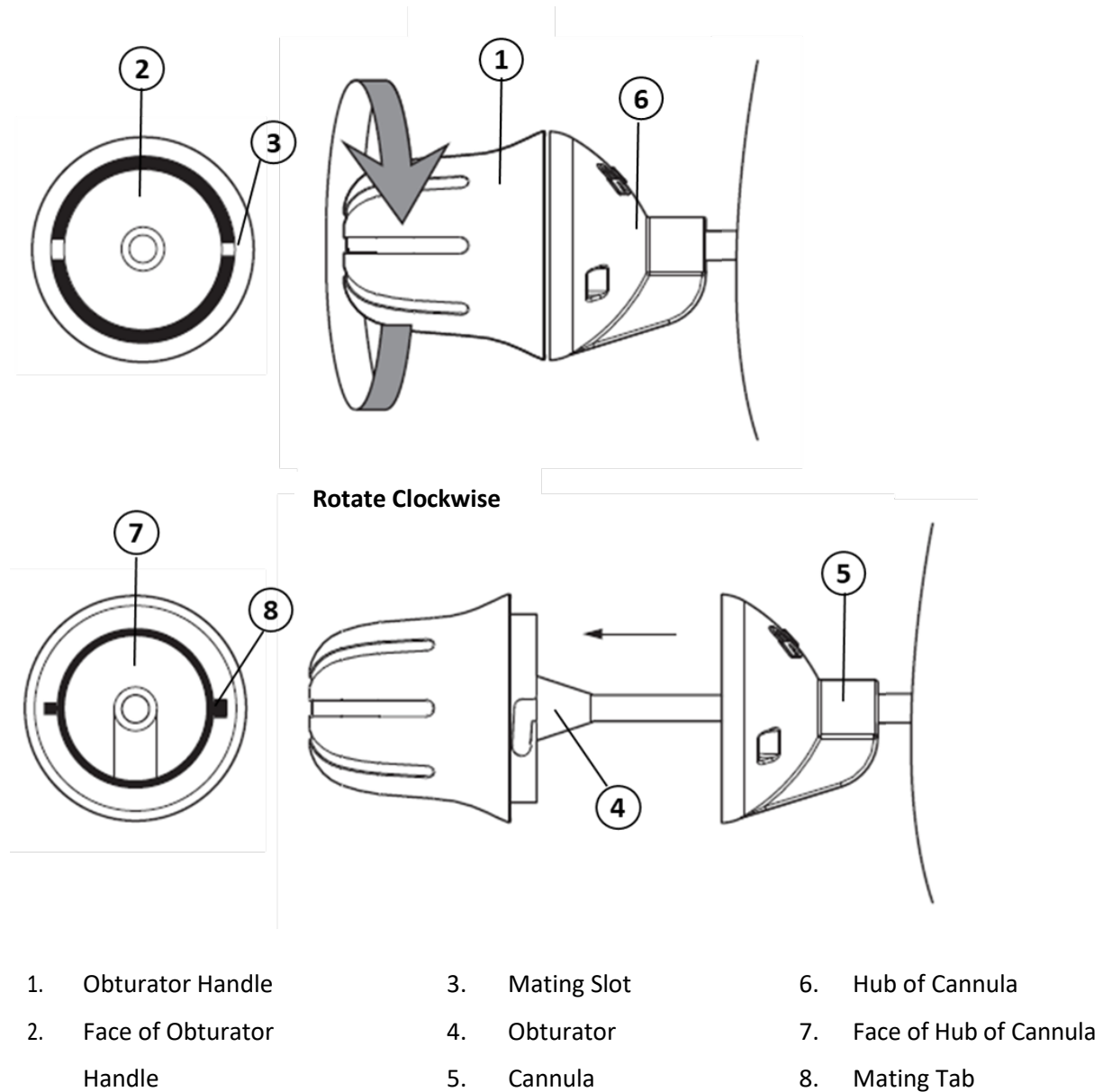

With the cannula in the appropriate position, hold the cannula and rotate the obturator hub clockwise until it stops. This will align the slot and tab allowing the obturator/cannula connection to be disengaged. While still holding the cannula in position, pull the obturator straight out of the cannula.

5.1.4 Mating arthroscope to Cannula

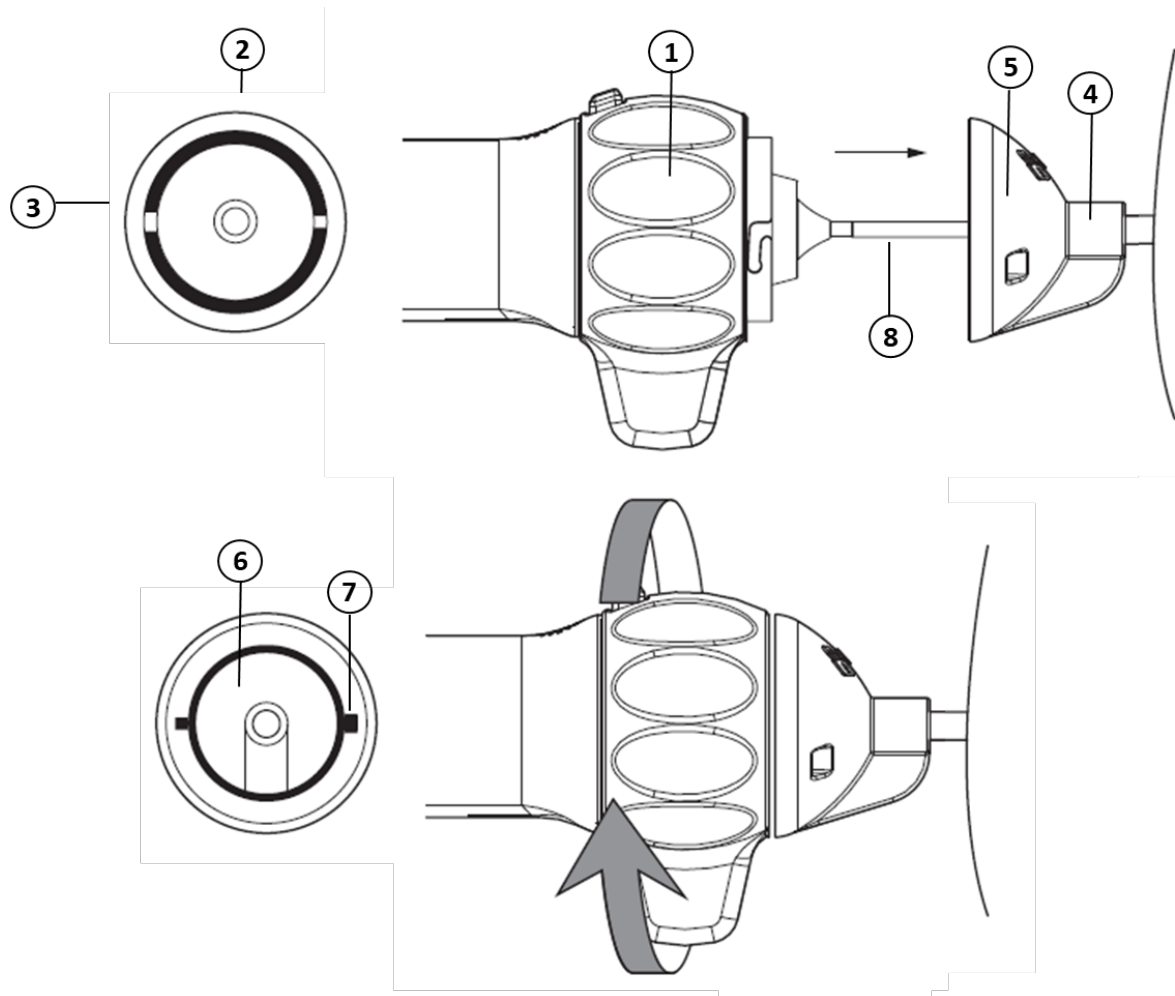







Rotate Counterclockwise

- | | |
|---------------------------|------------------------|
| 1. Control Handle | 5. Hub of Cannula |
| 2. Face of Control Handle | 6. Face of Cannula Hub |
| 3. Mating Slot | 7. Mating Tab |
| 4. Cannula | 8. Arthroscope Shaft |

The Face of the Control Handle has two slots on it. The Face of the Hub of the Cannula has two tabs on it. Hold the Hub of the Cannula in place. Insert the arthroscope Shaft into the lumen of the Cannula so that the Mating Tab is positioned to move toward the Mating Slot. Slide the Control Handle until the Mating Tab enters the Mating Slot on the Hub of the Control Handle. Done correctly, the Control Handle and the Hub of the Cannula will be flush to each other. There will be audible click and tactile confirmation as well. Holding the Hub of the Cannula in place, rotate the Control Handle counterclockwise to lock into place. Rotate the Control Handle clockwise to unlock.

5.2 Use

	WARNING: Do not continue operating if the image quality is poor or the image disappears.
	WARNING: Before use, check the insertion portion of the arthroscope and its accessories to be sure there are no rough surfaces, sharp edges or protrusions which may cause harm.
	WARNING: Do not apply arthroscopic surgical tools such as shaver blades or burrs to the end of the arthroscope.
	WARNING: Do not rest the arthroscope on the patient as the arthroscope Shaft may become hot (exceed 41°C).
	WARNING: To avoid the risk of electric shock, do not touch the Video Display Monitor Ports, USB Port, or USB Stick itself while touching the patient simultaneously.
	WARNING: Prior to the use of the arthroscope with other ME equipment, check to ensure all other ME equipment which comes into physical contact with the patient is of Type BF, or Type CF to avoid the risk of electric shock.



5.2.1 Control Button Functions / Media Processing

Function 1 – Digital Still Image Capture and Download:

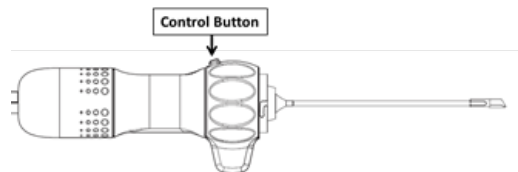
Press the Control Button once to capture a still image. The captured image will appear briefly in the lower right corner of the video display monitor. Image capture requires a USB Stick to be installed.



Function 2 - Digital Video Recording and Download:

Press the Control Button twice in quick succession to start video recording. A white, recording symbol  will appear in the upper left corner of the video display monitor and will slowly flash on and off indicating a video is recording. If a microphone has been successfully set up, the recording symbol will include a MIC icon . The video image will automatically begin to download to the USB stick and a white downloading symbol will display on the bottom left corner of the video display monitor. To end recording, double press the Control Button again. The recording symbol will turn gray and stop flashing indicating the recording has stopped. To utilize the Image Capture feature, a USB Stick must be installed in the Media Port found on the front panel of IPU.



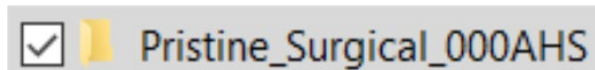

Note – Media Processing: To capture still images and/or videos, a USB stick must be inserted into the front panel Media Port and left in place while the images/videos are being recorded by the clinician. The images and videos will be automatically saved to the USB Stick and are not stored on the IPU. Images and videos are saved in one or more subfolders of the main folder that is named with the serial number of the arthroscope as shown here:



The files can be opened using basic media viewing programs, as the digital still images are captured as JPEG files, and the digital videos are captured as MP4 files, which are standard formats on most computers. The Filename will contain the following information and will appear in folders as shown below.

1. **Pristine Surgical**
2. **Scope Serial Number - Beginning 6 Characters**
3. **Date and time in a YYYYMMDD_HHMMSS format**
4. **Example: Pristine Surgical_ABC123_YYYYMMDD_HHMMSS.mp4 (video)**
Pristine Surgical_ABC123_YYYYMMDD_HHMMSS.png (still)

The numbers and letters represent the serial number of the scope. In that folder you will see the pictures and videos as shown below with the scope serial number along with the date and time.

 Pristine_Surgical_000AHS_20240708_090704_00	7/8/2024 9:07 AM	MP4 File
 Pristine_Surgical_000AHS_20240708_090720_00	7/8/2024 9:07 AM	MP4 File
 Pristine_Surgical_000AHS_20240708_090655286	7/8/2024 9:06 AM	PNG File
 Pristine_Surgical_000AHS_20240708_090702572	7/8/2024 9:07 AM	PNG File

5.2.2 Summit Settings App

The Summit Settings app supports the optimization of Summit 4K in the following ways:

1. The Summit Settings app allows for the surgeon and staff to perform camera functions by utilizing the tablet rather than the Summit Arthroscope.
2. Enhanced performance: The ability to zoom in/out and control the illumination levels is additional functionality to that of the Summit Arthroscope.

Compatible devices with Summit Settings app

The Summit Settings app can be used with iPadOS 17.5 and 9th and 10th Gen iPad in conjunction with the Pristine Surgical IPU.

Key Features

Summit Settings key features:

- Capturing still images
- Capturing videos
- Increasing and decreasing illumination levels
- Zooming in and out

Getting Started

- 1) Press the Summit Setting Icon, shown below, to open the app.



Summit Settings

Home Screen

From the tablet, the user has access to four tablet functions

- “Camera” captures still images
- “Zoom” allows the user to make the image appear larger and closer
- “Rec” starts a video recording with the first touch and stops the video with the second touch
- “Brightness” adjusts the illumination level

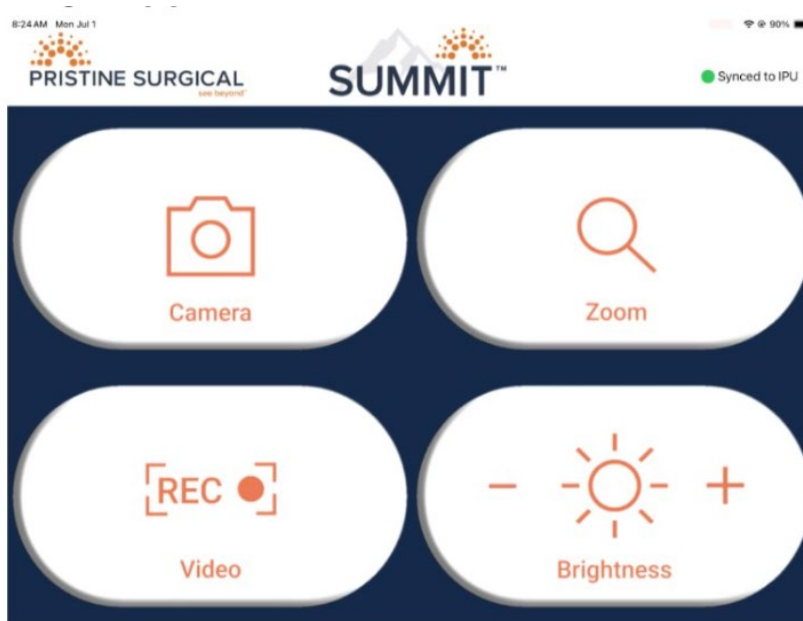

Syncing to IPU

To sync the tablet to the IPU, follow the steps below. These steps are also shown as they appear on the tablet.

Sync Device to IPU:

- 1) Confirm keyboard/mouse is connected to IPU
- 2) On IPU: Press Control + Shift + S to enter Setup Menu
- 3) On IPU: Click on the Bluetooth icon to enter the Bluetooth settings
- 4) If previously synced to the IPU,
 - a. On IPU Setup Menu: Select “Summit Settings” then click “Unpair”
 - b. On iPad: Use Settings>Bluetooth to forget IPU device
 - c. Return to Summit Settings app before continuing
- 5) On IPU: Click on “Scan”
- 6) On IPU: Click on “Summit Settings”

- 7) On IPU: Click "Pair"



Capturing still images

- 1) The camera button will change colors when pressed to show it has been engaged as shown below
- 2) The captured still image will appear briefly at the bottom right of the monitor as additional confirmation

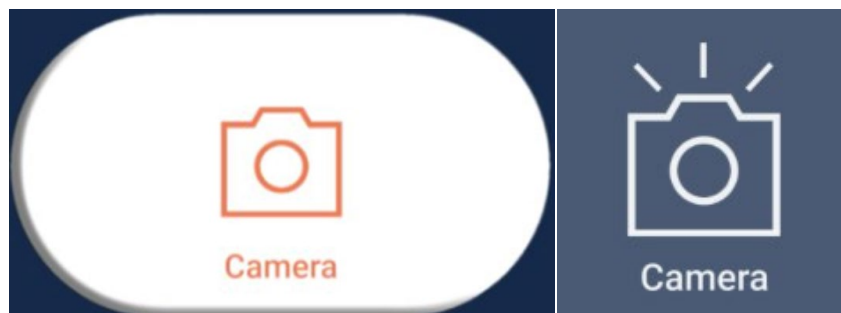

Starting a video

- 1) Press the record button to begin recording a video
- 2) The REC icon will turn blue when engaged as shown below
- 3) The video will appear in the top right corner of the of the monitor as additional confirmation

Stopping a video

- 1) Press again to stop recording

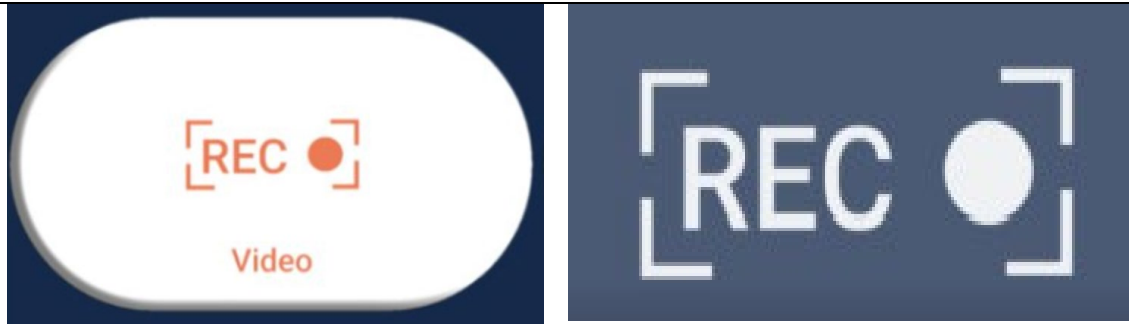

Illumination level

- 1) Brightness levels can be increased and decreased by using the brightness buttons +/-

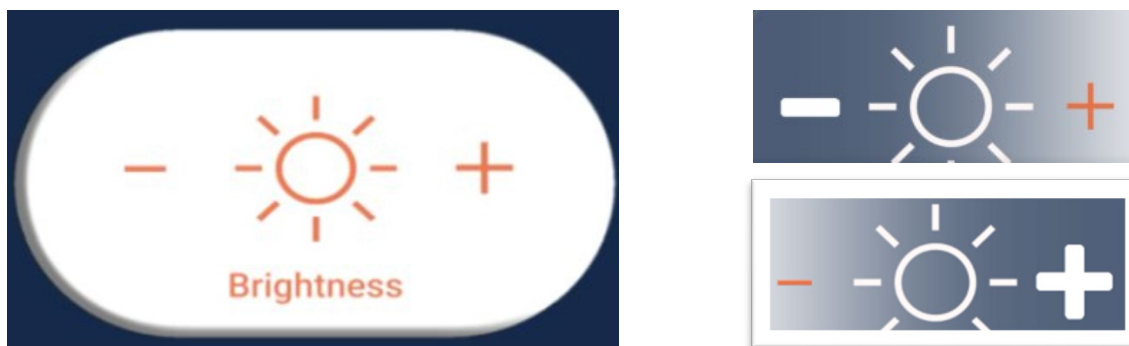

Zoom in/out

- 1) Press "Zoom" once to enlarge the image on the monitor
- 2) Press "Zoom" again to return to the regular image size



Application Version

To check the version of the application, follow these steps:

- 1) Open Settings: Tap on the Settings app on your iPad.
- 2) Navigate to General: Scroll down and tap on "General."
- 3) Tap on iPad Storage: Scroll down and tap on "iPad Storage."
- 4) Find the App: Scroll through the list of apps to find the one you're interested in. Tap on it.
- 5) App Information: The app information page will show the app's version number among other details

To unsync tablet from IPU:

- 1) On the tablet, go to settings
- 2) Choose Bluetooth
- 3) Find the IPU in the Bluetooth options
- 4) Click on the information icon
- 5) Choose “Forget this device”

5.2.3 Summit Voice Assistant

The Summit Voice Assistant (SVA) allows users to utilize voice commands to take pictures and start and stop videos.

To enable Summit Voice Assistant, click on the microphone icon, which will open up the Summit Voice Assistant menu.

By speaking clearly, with a microphone connected to the Pristine Surgical IPU, the system will recognize the following voice commands:

- “SUMMIT TAKE PICTURE” The system will take a picture
 - The image will appear on the bottom right of the monitor
- “SUMMIT START VIDEO” The system will start a video
 - An image will appear on the top right of the monitor
- “SUMMIT STOP VIDEO” The system will stop the video
 - An image will appear on the top right of the monitor

The system will provide the following voice feedback when the relevant voice commands are issued by the user:

“No Scope Connected” when any command is issued but no arthroscope is connected to the IPU

“Picture taken” when take picture command is issued

“Recording started” when the start video command is issued, and the system is not currently recording a video. –

“Recording is already in progress” when the start video command is issued, and the system is currently recording a video.

“Recording stopped” when the stop command is issued, and the system is currently recording a video.

“No recording in progress” when the stop command is issued, and the system is not currently recording a video.

Adjustments:

The settings screen allows for the following settings to be adjusted:

Microphone Sensitivity Threshold Slider:

This is a setting that allows users to adjust the microphone’s audio pick up based on environment conditions such as ambient noise etc.

Pause Time Slider:

The SVA uses this pause window to allow users a configurable time between the wake word and the CMD.

Language Model Selection:

This allows users to select one among many speech to text language models loaded into the SVA.

Voice Feedback Configuration:

This setting allows the user to enable or disable voice feedback from the IPU.

Buttons to Cancel or Apply Changes

- a. Cancel: The configuration values are discarded when this button is clicked.

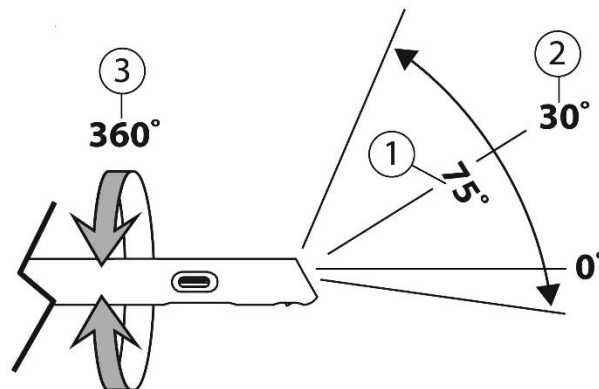
**5.2.4 Camera View**

1. Field of View
2. Direction of View
3. Rotation

Use the Fin on the Control Handle to adjust the rotation. The Rotation Marker on the perimeter of the displayed image follows this rotation.

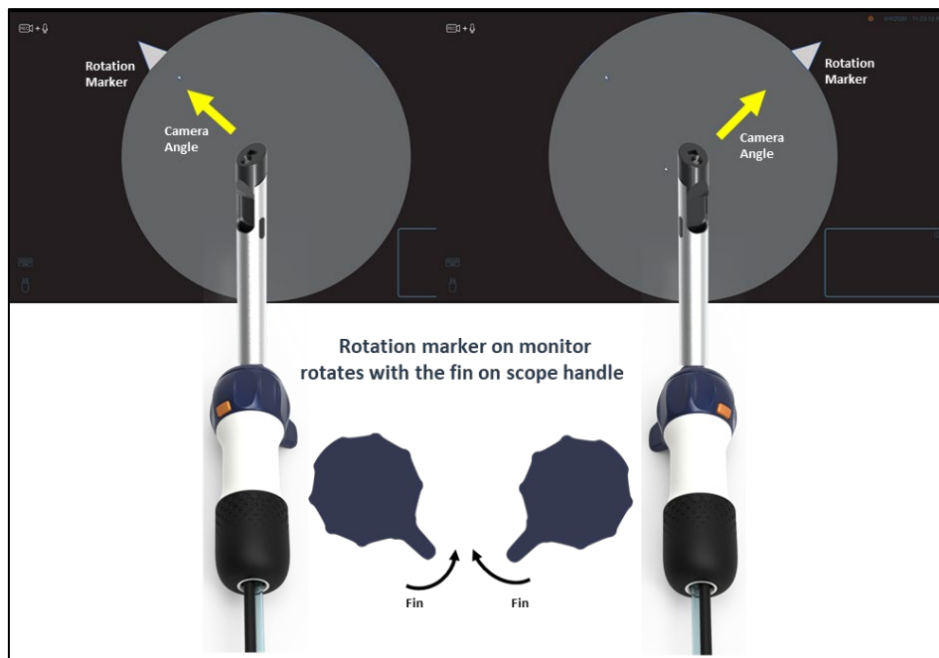
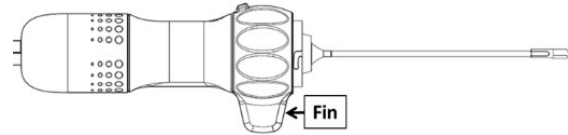

5.2.5 Shut Down

Upon completion of the procedure, unplug the arthroscope from the IPU. To ensure that the digital file is written to the USB Stick, do not turn the IPU off until processing has been completed. Press and release the power button to shut down the IPU.

6 Care, Maintenance, and Disposal

The arthroscope

Store the unopened arthroscope in its sterile sealed tray in a dry, clean area. See technical specifications for storage recommendations.

The IPU

The IPU is non-disposable and non-sterile.

If necessary, wipe off any spills and clean using an Intermediate Level Disinfectant ¹ on a damp cloth.

When not in use, unplug and store the IPU and the Power Cable together in a dry, clean area. See technical specifications for storage recommendations.

Contact Customer Service when the IPU has reached its service life to arrange returning it to the manufacturer.



WARNING: Do not modify or repair this equipment.

Disposal of arthroscope and Accessories

The arthroscope and its accessories are intended for single use.

















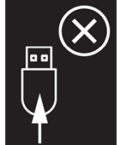



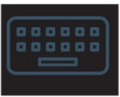
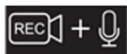

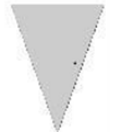





WARNING: Do not reuse the arthroscope or its accessories.

The arthroscope and its accessories must not be disposed of as unsorted municipal waste and must be collected separately in accordance with local, national, and institutional policies relating to obsolete medical device products.

¹A surface cleansing, intermediate-level disinfectant is a chemical agent that is tuberculocidal, effective against TB, HBV, HCV, viruses (hydrophilic and lipophilic), bacteria (including MRSA and VRE) and fungi. An example of this type of surface cleaning disinfectant is a product from Metrex called CaviCide.

7 Icons and Indicators on Video Display Monitor

	USB Stick Ready		Camera Ready
	USB Active Download		Camera Not Ready
	USB Stick Full		Video Not Ready
	USB Stick Error		Video Ready (No Audio)
	No USB Stick		Video + Audio Ready
	USB Keyboard Ready		Video + Audio Recording
	Connect Cable		Video Recording
	Rotation Marker		Error Statement 1
	Error Statement 2		Error Statement 3

	<p>Cloud Connected</p>		<p>Ethernet Connected</p>
	<p>Cloud Not Connected</p>		<p>Ethernet Connected, No Internet</p>
	<p>Upload in Progress</p>		<p>Wi-Fi Connected</p>
	<p>Upload Successful</p>		<p>Wi-Fi Not Connected</p>
	<p>Upload Failed</p>		<p>Wi-fi Connected, No Internet</p>
	<p>Voice App Icon</p>		

8 Troubleshooting









WARNING: Do not modify or repair this equipment.

Problem	Possible Cause	Possible Solution
Obturator will not disengage from Cannula	Locked in place	Rotate Obturator clockwise while holding tab on cannula in place.
Arthroscope will not engage and lock into Cannula	Arthroscope slot and cannula tab are not aligned	Align slot and tab and bring together so arthroscope and cannula are fully engaged
		Rotate arthroscope counterclockwise to lock into position
LED does not turn on	Control Button not held at least 3 seconds	Press and hold Control Button at least 3 seconds
LED turned off on its own	Arthroscope tip is too warm to continue	Restore irrigation flow When arthroscope tip temperature cools, use Control Button to turn LED back on
No still image captured	Control Button not completely depressed	Press Control Button completely
	USB Flash Memory Stick is full	Replace USB flash memory stick with one that is empty
	No USB stick plugged in	Plug-in USB Stick
No Video Image Recording	Control Button not completely depressed twice	Press the Control Button twice in quick succession
	USB Flash Memory Stick is full	Replace USB flash memory stick with one that is empty
	No USB stick plugged in	Plug-in USB Stick
Grey image on screen	No arthroscope connected	Plugin arthroscope
Black image on screen	LED not turned on	Turn on LED
Image blocked on one side	Arthroscope not locked into place in the Cannula	Fully rotate arthroscope control handle counterclockwise to lock into place
Poor Image Quality (Pixelated Image)	Camera too warm due to operation without irrigation fluid	Restore irrigation flow



	<p>LED not on</p> <p>Camera pointed at distant objects that are lit by normal room lighting</p> <p>Low light due to LED not illuminating as intended</p>	<p>Turn on LED, turn off LED if the arthroscope is not being used</p> <p>Point camera at an object that is within the working distance of the camera</p> <p>Replace arthroscope</p>
File missing or incomplete	<p>IPU was shut down while writing to USB Stick</p> <p>USB Stick was removed</p>	<p>Plug USB Stick back into IPU and let IPU finish writing</p> <p>Plug USB Stick into IPU and let IPU finish writing</p>
IPU rebooted	Power loss arthroscope malfunctioning	<p>Verify Electrical Connections</p> <p>Replace arthroscope</p>

8.1 Messages on Video Display Monitor

Icon	Message	Possible Cause	Possible Solution
	Connect Scope Cable (Icon)	No arthroscope connected Communication Cable not fully plugged in	Connect arthroscope, plug Communication Cable into IPU Plug-in Communication Cable
	No USB Stick (icon)	No USB stick plugged in	Plug-in USB Stick
	Camera not ready (icon)	USB Stick is full USB Stick is missing	Replace USB Stick with one that is empty Plug-in USB Stick
	Video Camera not ready (icon)	USB Stick is full USB Stick is missing	Replace USB Stick with one that is empty Plug-in USB Stick
	USB Stick Full (icon)	USB Stick is full	Replace USB Stick with one that is empty
	USB Stick error(icon)	USB Stick unplugged while writing is in progress	Plug USB Stick back in

Pristine Surgical INSTRUCTIONS FOR USE

IFU-300-001 Rev. J

	<p>USB Active Download (icon)</p>	<p>IPU is writing to USB Stick</p>	<p>Allow IPU to finish writing to USB Stick</p>
 <p>Error Statement 2</p>	<p>Scope Expired Icon</p>	<p>Scope was used previously, or a communications error or invalid configuration data was detected from the arthroscope</p>	<p>Replace arthroscope</p>

Note: If you need assistance with troubleshooting, please call Customer Service at 1-888-304-0004.

9 Technical Description

9.1 Technical Specifications

Physical Specifications

Shaft Length	125mm
Shaft Diameter	5.6mm
Field of View	75°
Direction of View	30°
Working Distance	5mm to 50mm
Weight: Image Processing Unit (IPU)	9500g /21 lbs.
Weight: Arthroscope	347g /12.2 oz
Weight: Obturator	42g /1.5 oz
Weight: Cannula	13g /0.5 oz
Image size	4K
Light source (arthroscope)	LED
Output Video	DisplayPort 1.2
Storage media	USB Stick 3.0, 32 GB (or greater), FAT32 or NTFS formatted
Still image file format	PNG
Still image size	2160 X 2160 (4K)
Saved video resolution	1080 X 1080 (1080p)
Video file format	MP4
Sterilization Method (arthroscope)	Ethylene Oxide Gas
Arthroscope Communication Cable Length	3m / 10 ft
Irrigation Tubing Length	200mm / 8 in
Irrigation Tubing Connector	Luer lock
Irrigation maximum supply pressure	7 Psi /360mm HG
Applied Part	Insertion portion of: Cannula, Scope Sheath, Obturator
Degree of Protection Provided by the Enclosure	IPU: IP20 Arthroscope: IP22 Arthroscope Tip: IPX8 (Note: Maximum fluid depth is 2.5 m for a maximum duration of 4 hours.)

Environmental Specifications

Operating Environment Temperature	10°C to 32°C
Operating Environment Relative Humidity	30% to 85% non-condensing
Operating Atmospheric Pressure	0 – 3,000 M
Transport and Storage Temperature	15°C to 30°C
Transport and Storage Relative Humidity	15% to 90% non-condensing
Transport and Storage Atmospheric Pressure	50kPa to 106kPa
Oxygen Rich Environment	Not suitable

Functional Specifications

Mode of Operation	Continuous
Maximum Operating Time	6 hours

Electrical Specifications

Nominal power	120V, 4.2A
Nominal frequency	60Hz
Degree of protection against electrical shock	Type BF Applied Part
Type of protection against electrical shock	Class I
Means to Isolate IPU from supply Mains	Appliance coupler and flexible cord with mains plug
Fuse Rating	250 V, 4 A, Slow Blow, High Breaking Capacity (T250VH4A)

Minimum Video Display Monitor Requirement

Resolution	1080 P
Aspect Ratio	16: 9 (horizontal: vertical)
Interface	DisplayPort
Certification	IEC/UL 60601-1
Response Time	30ms or less

Irrigation Pump Requirements



Source Pressure	7 Psi /360mm HG
Maximum Flow Rate	420 mL/min
Pump Tubing	Terminates in a male Luer lock connector

9.2 Electromagnetic Compatibility

Like other electrical medical equipment, the Summit™ single-use arthroscope requires special precautions to ensure electromagnetic compatibility (EMC) with other electrical medical devices. To ensure electromagnetic compatibility, the Summit™ single-use arthroscope must be installed and operated according to the EMC information provided in this manual.

To comply with FCC RF radiation exposure limits for the general population, the antenna(s) used for this transmitter must be installed such that a minimum separation distance of 20cm is always maintained between the radiator (antenna) and all persons and must not be co-located or operating in conjunction with any other antenna or transmitter.

NOTE: This equipment has been tested and found to comply with the limits for a Class A digital device, pursuant to part 15 of the FCC Rules. These limits are designed to provide reasonable protection against harmful interference when the equipment is operated in a commercial environment. This equipment generates, uses, and can radiate radio frequency energy and, if not installed and used per the instruction manual, may cause harmful interference to radio communications. Operation of this equipment in a residential area is likely to cause harmful interference in which case the user will be required to correct the interference at their own expense.

	<p>WARNING: Use of accessories or cables (Communication Cable and Power Cord) other than those specified or provided by the manufacturer of this equipment could result in increased electromagnetic emissions or decreased electromagnetic immunity of this equipment and result in improper operation.</p>
	<p>WARNING: Use of this equipment adjacent to or stacked with other equipment should be avoided because it could result in improper operation. If such use is necessary, this equipment and the other equipment should be observed to verify that they are operating normally.</p>
	<p>WARNING: Portable RF communication equipment (including peripherals such as antenna cables and external antennas) should be used no closer than 30cm (12 inches) to any part of the arthroscope or IPU, including cables specified by the manufacturer; otherwise, degradation of performance of this equipment could result.</p>

Unintended electromagnetic disturbances may cause the Pristine Surgical System to exhibit any of the following performance degradation conditions.

- Loss of live video
- System shutdown
- Blank monitor screen
- Static image on monitor
- Shifts in orientation.
- Changes in color
- Poor illumination
- Image artifacts

Note: The emissions characteristics of this equipment make it suitable for use in industrial areas and hospitals (CISPR 11 Class A). This unit is not designed to be utilized in a residential environment.

Note: The Summit™ single-use arthroscope has been designed and tested to comply with IEC 60601-1-2: 2014 requirements for EMC with other devices.

Guidance and Manufacturer’s Declaration: Electromagnetic Emissions		
The Summit™ single-use arthroscope is intended for use in the electromagnetic environment specified below. The customer or user of the Summit™ single-use arthroscope should ensure that it is used in such an environment.		
Emissions test	Compliance	Electromagnetic Environment - guidance
Radiated emissions CISPR 11	Group 1, Class A	The Summit™ single-use arthroscope uses RF energy only for its internal function; therefore, its RF emissions are very low and are not likely to cause any interference in nearby electronic equipment.
Conducted emissions CISPR 11	Group 1, Class A	The Summit™ single-use arthroscope is suitable for use in all establishments other than domestic establishments and those directly connected to the public low-voltage power supply network that supplies building used for domestic purposes, provided the following warning is heeded:
Harmonic Current emissions IEC 61000-3-2	Not applicable	WARNING: This system is intended for use by health care professionals only. This system may cause radio interference or may disrupt the operation of nearby equipment. It may be necessary to take mitigation measures, such as reorienting or relocating the system or shielding the location.
Voltage Fluctuations and Flicker, IEC 61000-3-3	Not applicable	

Guidance and Manufacturer’s Declaration: Electromagnetic Immunity

The Summit™ single-use arthroscope is intended for use in the electromagnetic environment specified below. The customer or user of the Summit™ single-use arthroscope should ensure that it is used in such an environment.

Immunity Test	IEC 60601-1-2 Test Level	Compliance Level	Electromagnetic Environment - guidance
Electrostatic Discharge (ESD) IEC 61000-4-2	±8kV contact ±2kV, ±4kV, ±8kV, ±15kV air	±8kV contact ±2kV, ±4kV, ±8kV, ±15kV air	Floors should be wood, concrete, or ceramic tile. If floors are covered with synthetic material, the relative humidity should be at least 30%.
Electrical fast transient/burst IEC 61000-4-4	±2kV for power supply lines ±1kV for input/output lines	±2kV for power supply lines ±1kV for input/output lines	Mains power quality should be that of a typical commercial or hospital environment.
Surge IEC 61000-4-5	±0.5kV, ±1kV differential mode ±0.5kV, 1Kv, 2Kv common mode	±0.5kV, ±1kV differential mode ±0.5kV, 1Kv, 2Kv common mode	Mains power quality should be that of a typical commercial or hospital environment.
Voltage dips, short interruptions, and voltage variations on power supply input lines IEC 6100-4-11	0% UT (100% dip in UT) for 0.5 cycle, 0% UT (100% dip in UT) for 1 cycle, 70% UT (30% dip in UT) for 25/30 cycles, 0% UT (100% dip in UT) for 250/300 cycles,	0% UT (100% dip in UT) for 0.5 cycle, 0% UT (100% dip in UT) for 1 cycle, 70% UT (30% dip in UT) for 25/30 cycles, 0% UT (100% dip in UT) for 250/300 cycles	Mains power quality should be that of a typical commercial or hospital environment. If the user of the Summit™ single-use arthroscope requires continued operation during power mains interruptions, it is recommended that the Summit™ single-use arthroscope be powered from an uninterruptible power supply or battery.
Power frequency (50/60Hz) magnetic field IEC 61000-4-8	30 A/m	30 A/m	Power-frequency magnetic fields should be at levels characteristic of a typical location in a typical commercial or hospital environment.

<p>Conducted RF IEC 61000-4-6</p>	<p>3 Vrms 150 kHz to 80 MHz outside of ISM bands^(c)</p> <p>6 Vrms 150 kHz to 80 MHz in ISM bands^(c)</p>	<p>3 Vrms 150 kHz to 80 MHz outside of ISM bands^(c)</p> <p>6 Vrms 150 kHz to 80 MHz in ISM bands^(c)</p>	<p>Portable and mobile RF communications equipment should be used no closer to any part of the Summit™ single-use arthroscope, including its cables, than the recommended separation distance calculated from the equation applicable to the frequency of the transmitter.</p> <p>Recommended Separation Distance</p> $d = \frac{3.5}{3} \sqrt{P}$ $d = \frac{3.5}{6} \sqrt{P}$
<p>Radiated RF IEC 61000-4-3</p>	<p>3 V/m 80 MHz to 2.7 GHz</p>	<p>3 V/m 80 MHz to 2.7 GHz</p>	$d = \frac{3.5}{3} \sqrt{P} \text{ 80MHz to 800MHz}$ $d = \frac{7}{3} \sqrt{P} \text{ 800MHz to 2.7GHz}$ <p>Where is P is the maximum output power rating of the transmitter in watts (W) according to the transmitter manufacturer and d is the recommended separation distance in meters (m).</p> <p>Field strengths from fixed RF transmitters, as determined by an electromagnetic survey ^(a), should be.</p> <p>less than the compliance level in each frequency range ^(b). Interference may occur in the vicinity of equipment. marked with the following:</p> 
<p>NOTE 1: UT is the AC mains voltage prior to application of the test level.</p>			
<p>NOTE 2: At 80 MHz and 800 MHz, the higher frequency range applies.</p>			
<p>NOTE 3: These guidelines may not apply in all situations. Electromagnetic propagation is affected by absorption and reflection from structures, objects, and people.</p>			

(a) Field strengths from fixed transmitters, such as base stations for radio (cellular/cordless) telephones and land mobile radios, amateur radio, AM and FM radio broadcast, and TV broadcast, cannot be predicted theoretically with accuracy. To assess the electromagnetic environment due to fixed RF transmitters, an electromagnetic site survey should be considered. If the measured field strength in the location in which the Summit™ single-use arthroscope is used exceeds the applicable RF compliance level above, the Summit™ single-use arthroscope should be observed to verify normal operation. If abnormal performance is observed, additional measures may be necessary, such as reorienting or relocating the Summit™ single-use arthroscope.











(b) Over the frequency range 150 kHz to 80 MHz, field strengths should be less than 3V/m.









(c) The ISM (industrial, scientific, and medical) bands between 0.15 MHz and 80 MHz are 6.765 MHz to 6.795 MHz, 13.553 MHz to 13.567 MHz, 26.957 MHz to 27.283 MHz, and 40.66 MHz to 40.70 MHz

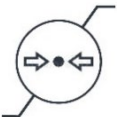

Recommended Separation Distances Between Portable and Mobile RF Communications Equipment and the Summit™ single-use arthroscope				
	The Summit™ single-use arthroscope is intended for use in an electromagnetic environment in which radiated RF disturbances are controlled. The user of the Summit™ single-use arthroscope can help prevent electromagnetic interference by maintaining a minimum distance between portable and mobile RF communications equipment (transmitters) and the Summit™ single-use arthroscope as recommended below, according to the maximum output power of the communications equipment.			
Rated maximum output power (W) of transmitter	Separation distance (m) according to the frequency of transmitter			
	150 kHz to 80 MHz outside of ISM bands $d = \frac{3.5}{3} \sqrt{P}$	150 kHz to 80 MHz inside of ISM bands $d = \frac{3.5}{6} \sqrt{P}$	80 MHz to 800 MHz $d = \frac{3.5}{3} \sqrt{P}$	800 MHz to 2.7 GHz $d = \frac{7}{3} \sqrt{P}$
0.01	0.12	0.06	0.12	0.23
0.1	0.37	0.18	0.37	0.74
1	1.17	0.58	1.17	2.33
10	3.69	1.84	3.69	7.38
100	11.7	5.83	11.7	23.3
	For transmitters rated at a maximum output power not listed above, the recommended separation distance (d) in meters (m) can be estimated using the equation applicable to the frequency of the transmitter, where P is the maximum output power rating of the transmitter in watts (W) according to the transmitter manufacturer.			
	NOTE 1: At 80 MHz and 800 MHz, the separation distance for the higher frequency range applies.			
	NOTE 2: These guidelines may not apply in all situations. Electromagnetic propagation is affected by absorption and reflection from structures, objects, and people.			

10. Symbols Used on the System

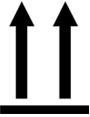
This section defines the symbols used in this guide, on the Summit™ single-use arthroscope, IPU, and all packaging.

Symbol	Title	Explanatory Note	Reference Number	EndNote
	Manufacturer	Indicates the medical device manufacturer and date when the medical device was manufactured.	5.1.1	1
	Catalog Number	Indicates the manufacturer's catalog number so that the medical device can be identified.	5.1.6	1
	Serial Number	Indicates the manufacturer's serial number so that a specific medical device can be identified.	5.1.7	1
	Do Not Reuse	Indicates a medical device that is intended for one use or for use on a single patient during a single procedure.	5.4.2	1
	Use-by Date	Indicates the date after which the medical device is not to be Used. Date format is YYYY-MM-DD	5.1.4	1
	Follow Instructions For Use	To signify that the instruction manual must be read.	Table D.2, No. 10	2
	Sterilize Using Ethylene Oxide	Indicates a medical device that has been sterilized using ethylene oxide.	5.2.3	1
	Type BF Applied Part	To identify a type of BF Applied part complying with IEC60601- 1.	Table D.1, No. 20	2
	IP Code	A code for the degree of protection provided by an enclosure. The 2 indicates protection against access to hazardous parts with a finger. The 0 indicates no protection against ingress of water with harmful effects.	Table D.3, No.2	2
	IP Code	A code for the degree of protection provided by an enclosure. The 2 indicates protection against access to hazardous parts with a finger. The 2 indicates protection against	Table D.3, No.2	2

		vertically falling water drops. when enclosure tilted up to 15°.		
IPX8	IP Code	A code for the degrees of protection provided by an enclosure. The X indicates protection is not specified. The 8 indicates protection against the effects of continuous immersion in water.	Table D.3, No.2	2
	Fragile, Handle with Care	Indicates a medical device that can be broken or damaged if not handled carefully.	5.3.1	1
	Temperature Limit	Indicated the temperature limits to which the medical device can be safely exposed.	5.3.7	1
	Humidity Limitation	Indicates the range of humidity to which the medical device can be safely exposed.	5.3.8	1
	Atmospheric Pressure Limitation	Indicates the acceptable upper and lower limits to which the medical device can be safely exposed.	5.3.9	1
	Keep Dry	Indicates a medical device that needs to be protected from moisture.	5.3.4	1
	General Warning Sign	To signify a general warning.	Table D.2, No. 2	2
	Stand-by	To identify the switch by means of which part of the equipment is switched on to bring it into the stand-by condition.	Table D.1, No.29	2
	This Way Up	This is the correct upright position of the distribution packages for transport and/or storage.	Table 5, No.13	3
	Alternating Current	To indicate the equipment is suitable for alternating current only.	Table D.1, No.1	2
Rx ONLY	Prescription Device	Federal law restricts this device to sale by or on the order of a physician.	N/A	4

	<p>Medical Device</p>	<p>Indicates that the item is a medical device.</p>	<p>5.7.7</p>	<p>1</p>
	<p>Non-Ionizing Electromagnetic Radiation</p>	<p>To indicate generally elevated, potentially hazardous, levels of non-ionizing radiation, or to indicate equipment or systems e.g., in the medical electrical area that includes RF transmitters or that intentionally apply RF electromagnetic energy for diagnosis or treatment.</p>	<p>5.1.4</p>	<p>5</p>

End Notes:

1. ISO 15223-1: 2012 Medical devices—Symbols to be used with medical device labels, labeling and information to be supplied—Part 1: General requirements.
2. IEC 60601-1: 2005 + A2: 2020 Medical electrical equipment—Part 1: General requirements for basic safety and essential performance
3. ISO 780: 2015 Packaging—Distribution Packaging—Graphical Symbols for handling and storage of packages
4. 21 CFR 801.109(b)(1): CFR – Code of Federal Regulations Title 21 – FDA Subchapter H – Medical Devices, Part 801.109- Prescription Devices
5. IEC 60417—Graphical Symbols for Use on Equipment

11 Abbreviation Glossary

Abbreviation	Definition
AM	Amplitude Modulation
DP	DisplayPort
FAT32	File Allocation Table (32-bit)
FM	Frequency Modulation
IPU	Image Processing Unit
LED	Light- Emitting Diode
NTFS	New Technology File System
RF	Radio Frequency
TV	Television
USB	Universal Serial Bus

12 Customer Service

If any part of the system is not working, please contact Customer Service at:

www.pristinesurgical.com or 1-888-304-0004 or at feedback@pristinesurgical.com



Pristine Surgical
Brady Sullivan Tower, 6th Floor
1750 Elm Street
Manchester NH 03104
www.pristinesurgical.com | 1-888-304-0004